

# Musterring

DELPHI BOXSPRING



## Betriebsanleitung

(Bitte aufbewahren, Stand 28.01.2022)



Musterring

# Nutzen Sie die Sicherheit einer großen Marke.



## 5 Jahre Garantie.

Auf Musterring Möbel ist Verlass.

Die Garantiebestimmungen, Gebrauchs- und Pflegeanweisungen sind im Musterring Möbel-Gütepass geregelt.



## Service-Information

Sie erreichen uns per E-Mail oder über das Servicetelefon zu den üblichen Geschäftszeiten.



## Individualität

Die Musterring Produktkennzeichnung belegt, dass Sie ein Unikat gekauft haben.



## Pflege

Wir empfehlen Musterring Pflegeprodukte.

## Lederpflege & Reinigung

Stoff-/ Mikrofaserpflege & Reinigung

Holzpflege und Sonderprodukte



Zu bestellen unter [www.musterring-care.com](http://www.musterring-care.com)

oder unter der kostenlosen Beratungsnummer

+ 49 (0) 800 / 88 88 885.

Bei Fragen sprechen Sie uns bitte an;

wir helfen Ihnen gerne weiter.

**Zur Werterhaltung Ihrer Möbel**



„Wichtig: Gebrauchs- und Montageanleitung für spätere Bezugnahme aufbewahren, sorgfältig lesen“

"Important: for future reference please keep the assembly instruction, read it carefully"

Modelle mit Lichtquellen: Die Lichtquellen und die separaten Steuerungselemente können zur Überprüfung durch die Marktüberwachungsbehörde / als Austauschteil aus dem umgebenden Produkt entnommen werden, ohne sie dauerhaft zu zerstören. Anweisungen dazu finden Sie in der technischen Dokumentation des Produktes.



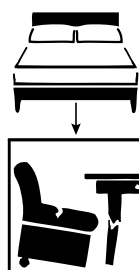
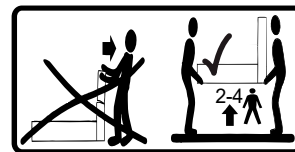
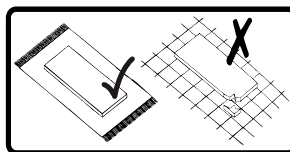
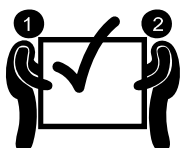
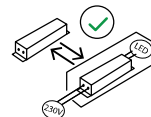
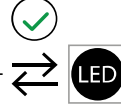



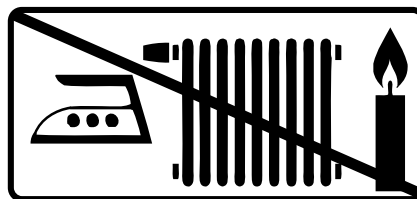
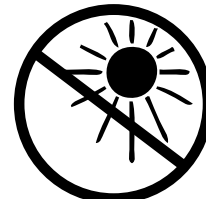
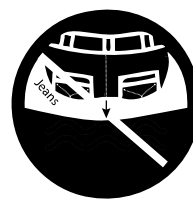
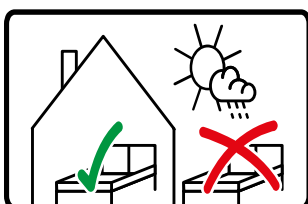
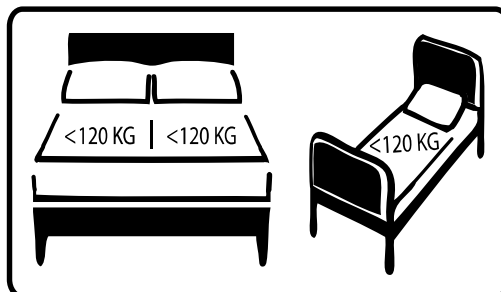
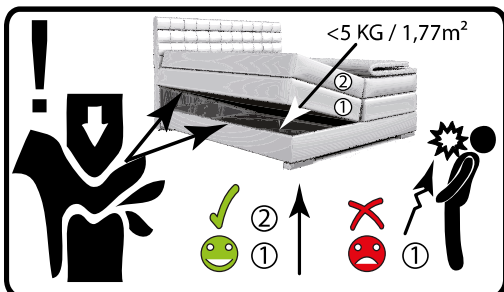
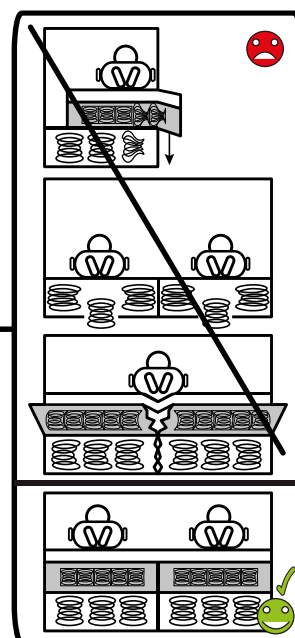





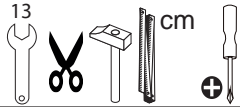

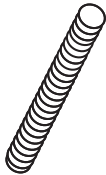
Models incl. LED Light: The light sources and the separate control elements can be removed from the surrounded product for inspection by the market surveillance authority / as replacement part without permanently destroying them. Instructions for this can be found in the technical documentation of the product.

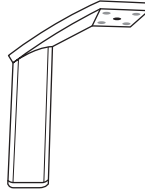

Sperrmüll / bulky waste

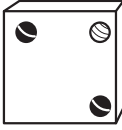

инструкции за монтаж / návod k montáži / monteringsvejledning / instrucciones de montaje / monterimisjuhendid / instructions de montage / asennusohjeet / οδηγίες συναρμολόγησης / szerelési útmutató / upute za montažu / istruzioni di montaggio / montāžas instrukcijas / surinkimo instrukcijos / montage-instructies / instruções de montagem / instrukcja montażu / instrucțiunile de asamblare / инструкции по сборке / monteringsanvisningar / návod na montáž / navodila za montažo / montaj talimatları

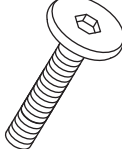
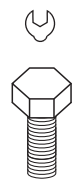
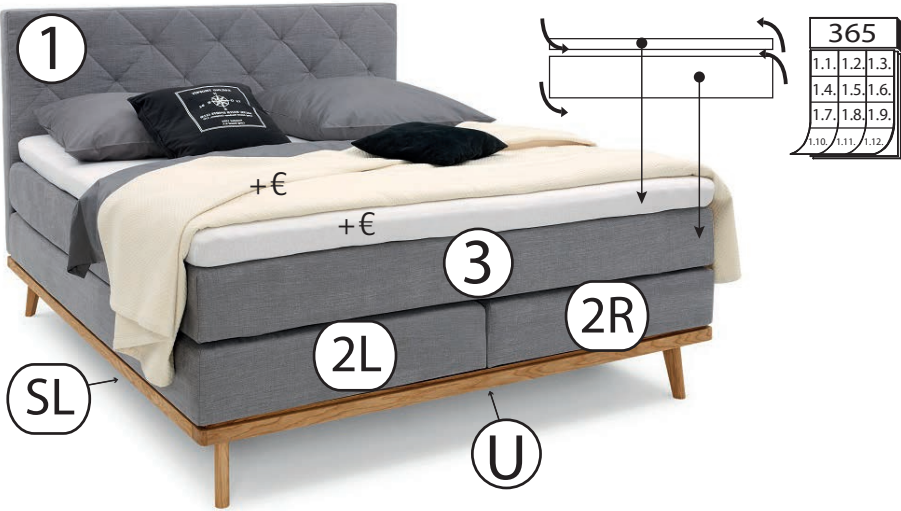
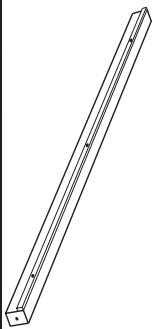
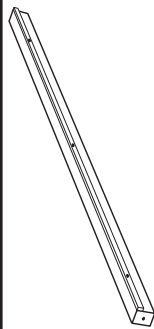
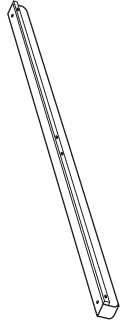
   		Boxspring							140 x 200 cm 160 x 200 cm 180 x 200 cm
A-86	B-86	C-86	D-86	E-86	F-86	G-86	H-86	I-86	
6	4	10	12	4	16	4	-	1	
M8 							-		
H: 220	M8*80	M8*35	M8*25	M8	-	H: 180	-	5	
J-86	K-86	L-86	M-86	N-86	O-86	P-86	Q-86	R-86	
4	4	8	2	6	4	4	-	-	
M8 							-	-	
H: 180	H: 40	M8*70	M8*50	4*70	M8*70	M8*45	-	-	
SL-86	TR-82	U-86							
1	1	1							
									
2.050*65*40		140cm: 1.400* 160cm: 1.600* 180cm: 1.800* 65*40							

**1**

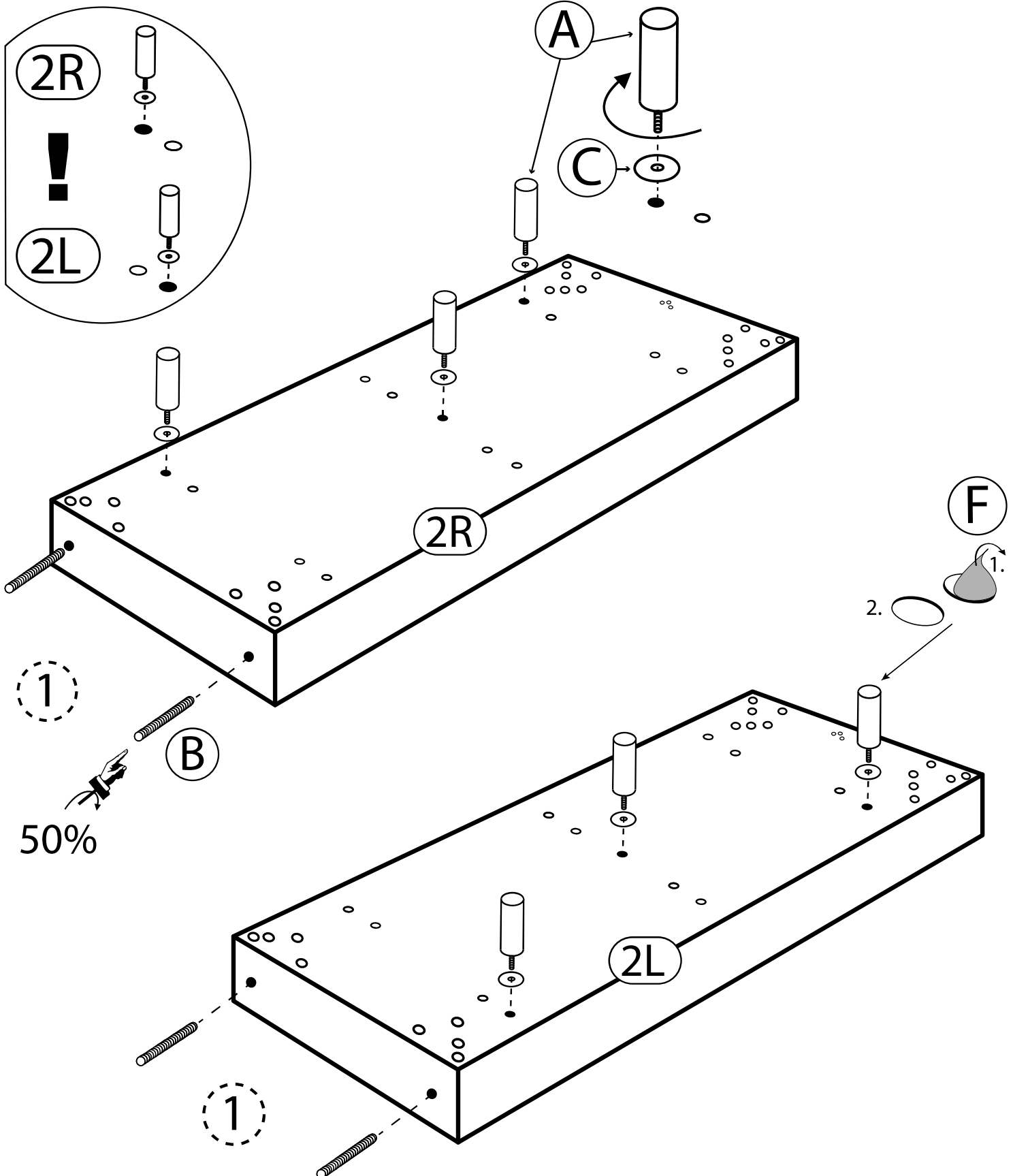

**2 G**

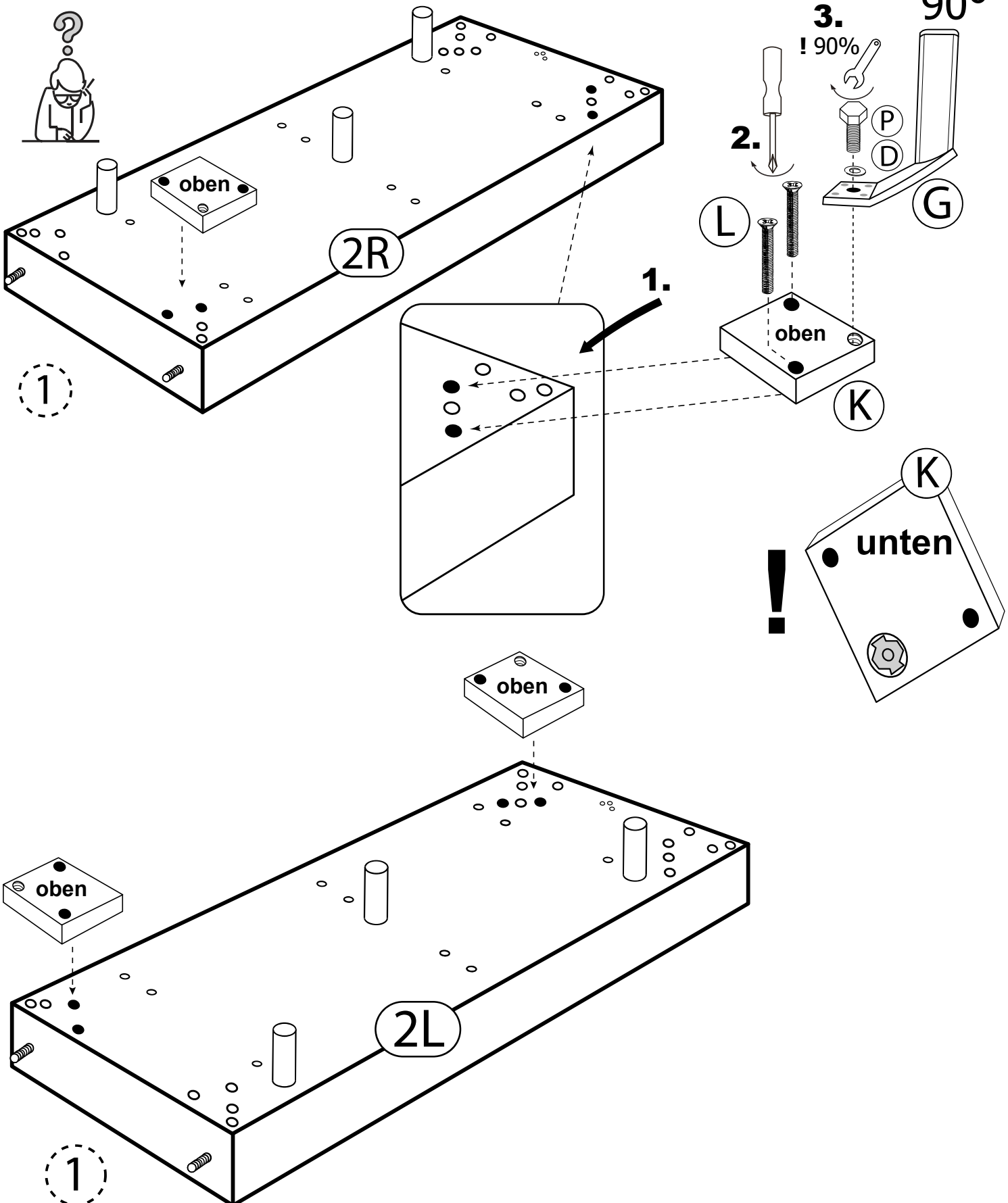

**3 J**

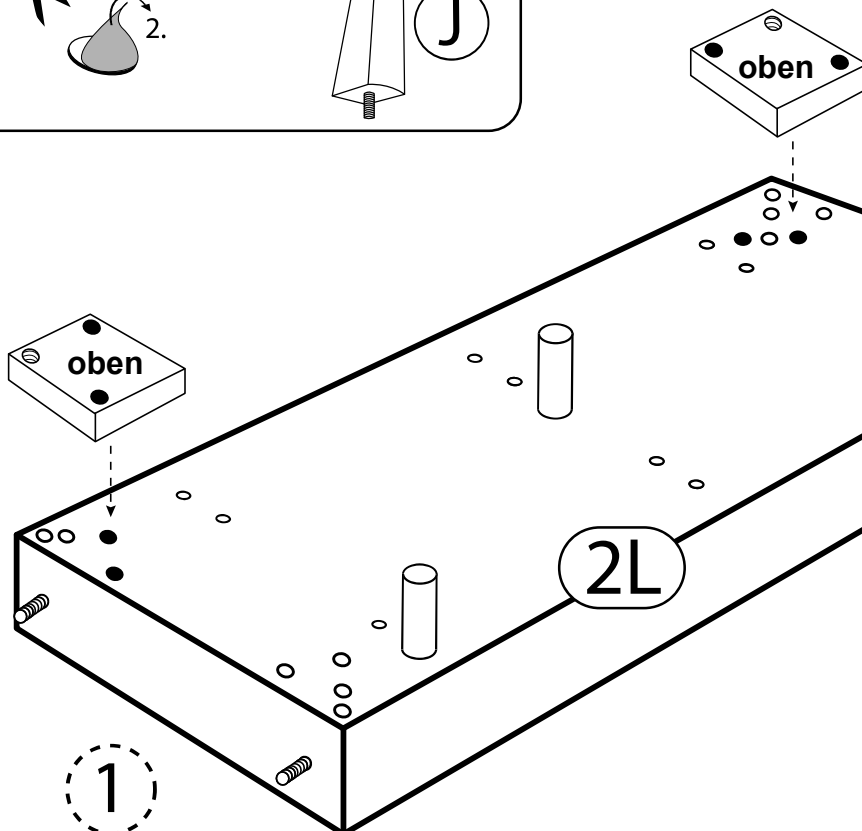
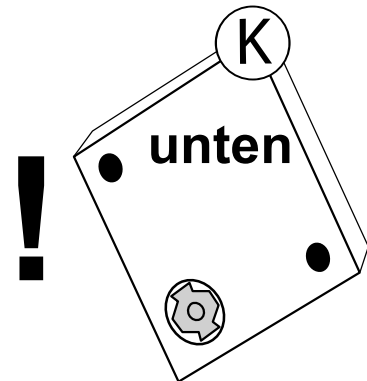
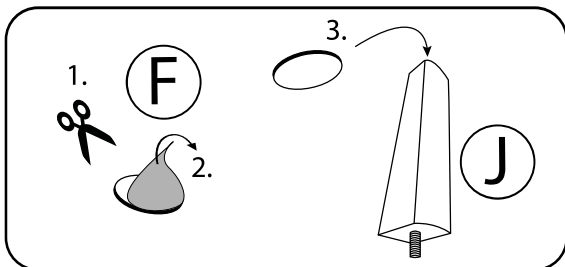
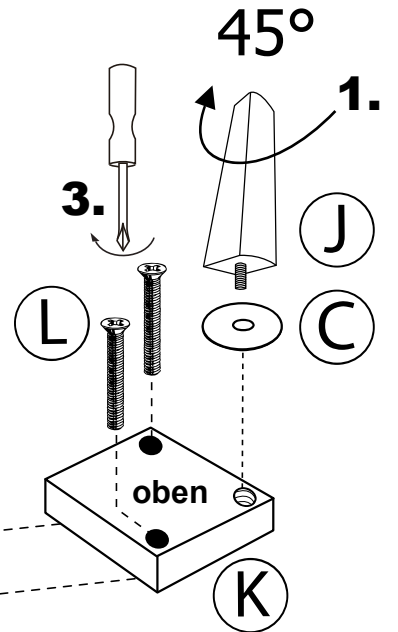
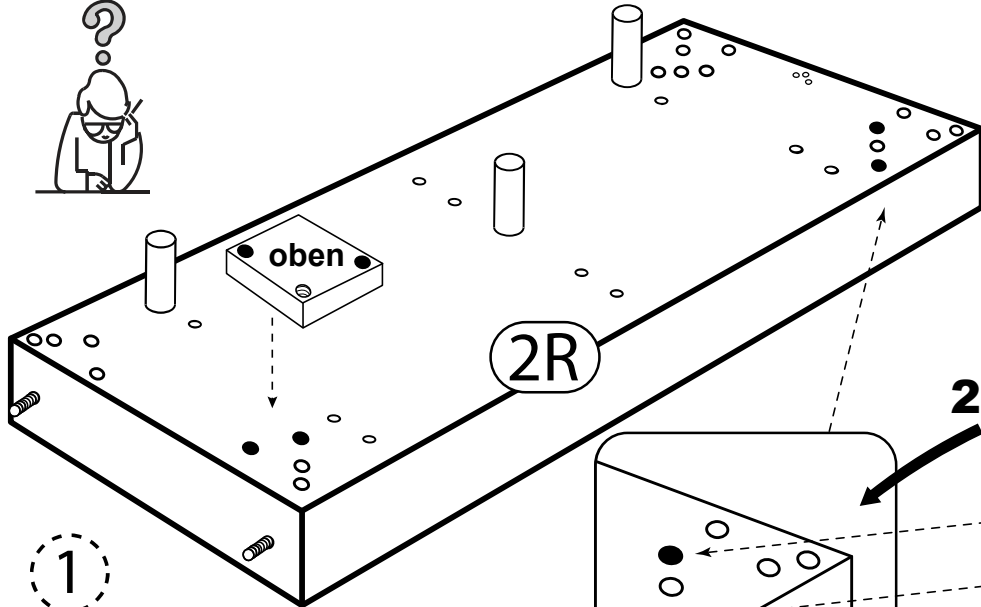

4

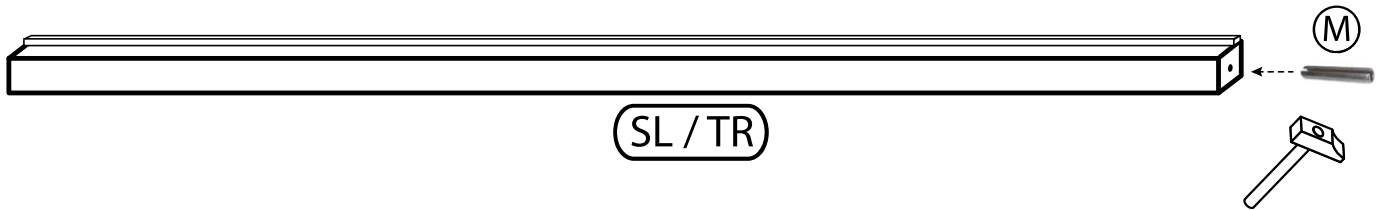

5

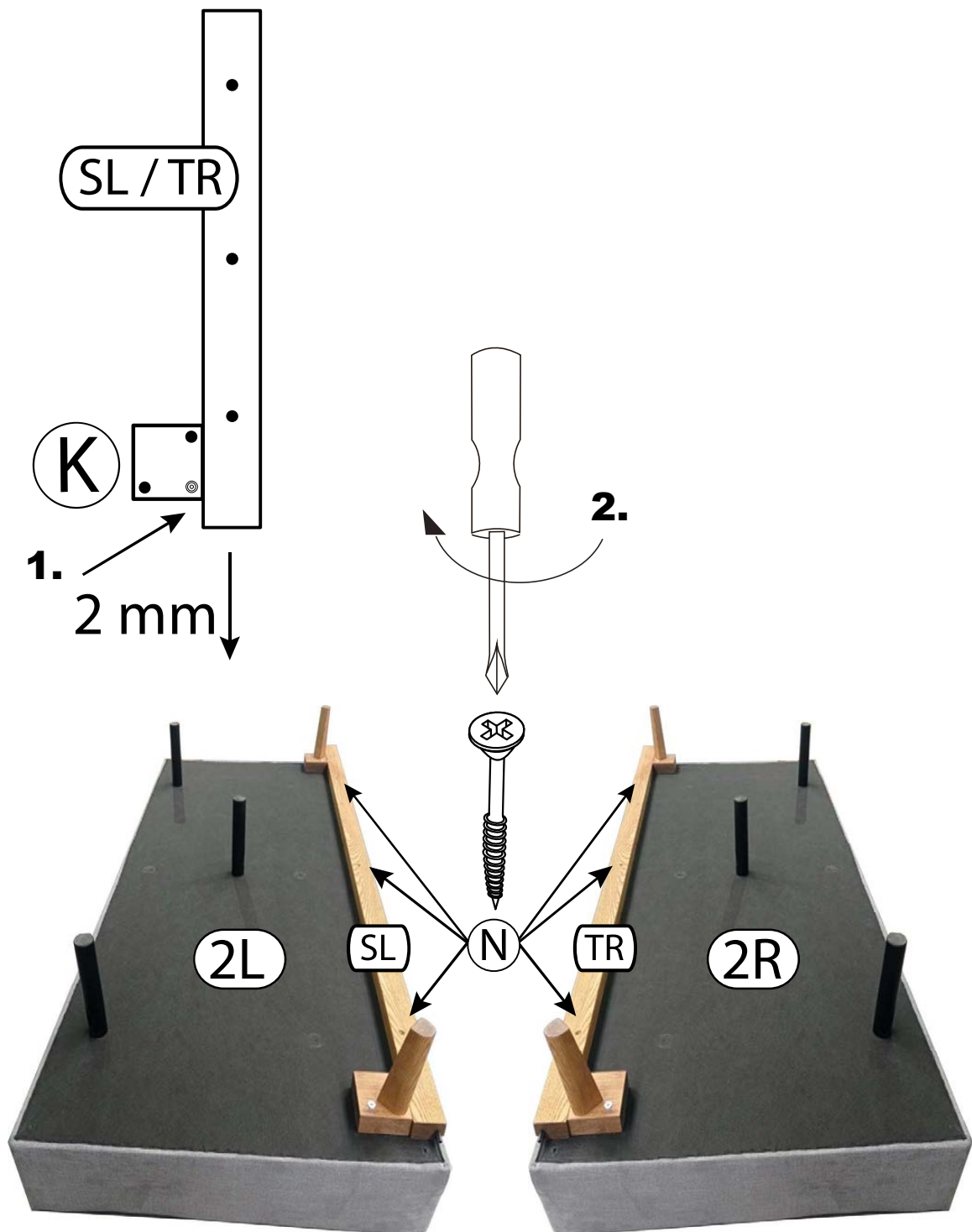



# DELPHI

## Boxspring

140 x 200 cm  
160 x 200 cm / 180 x 200 cm

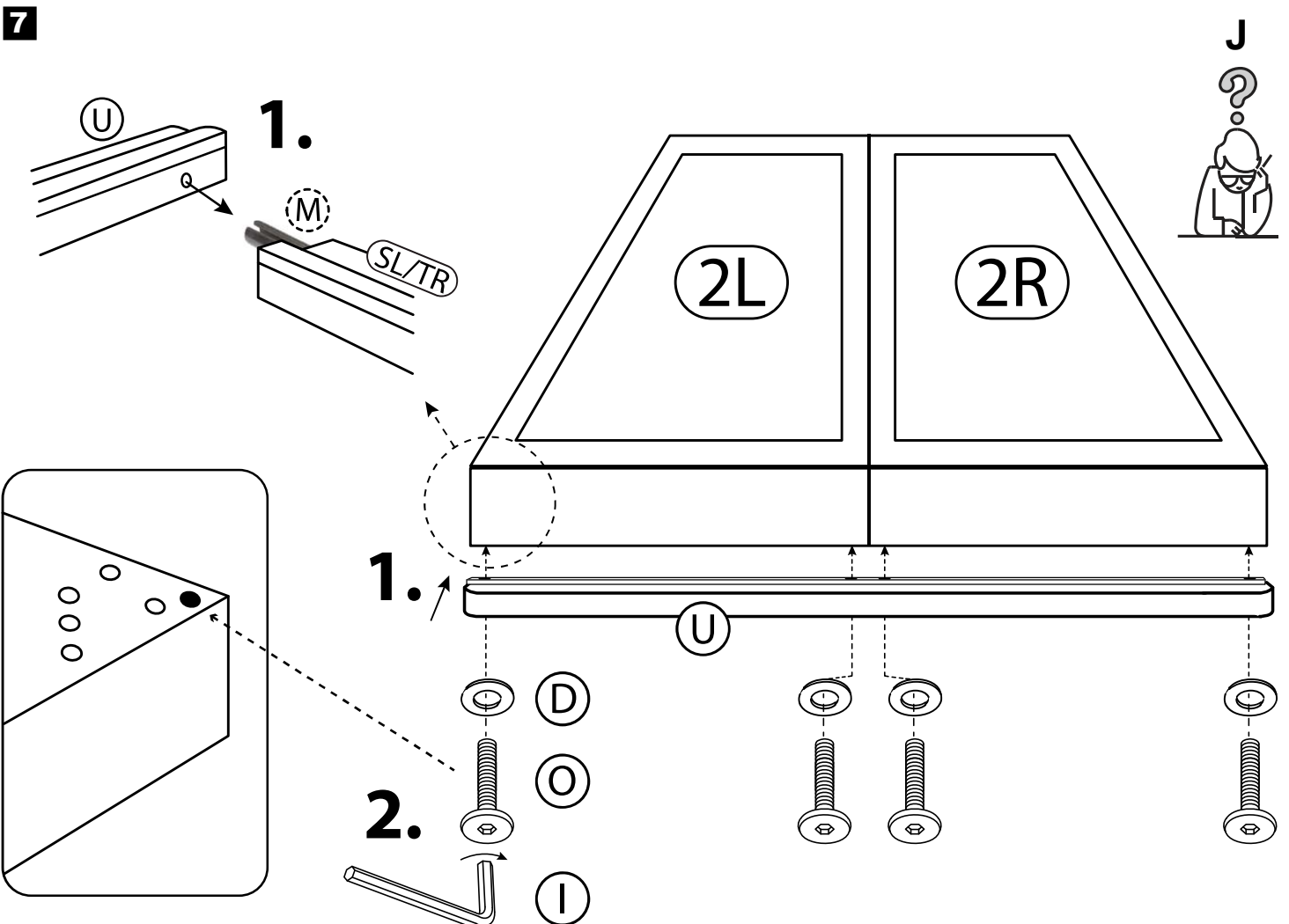
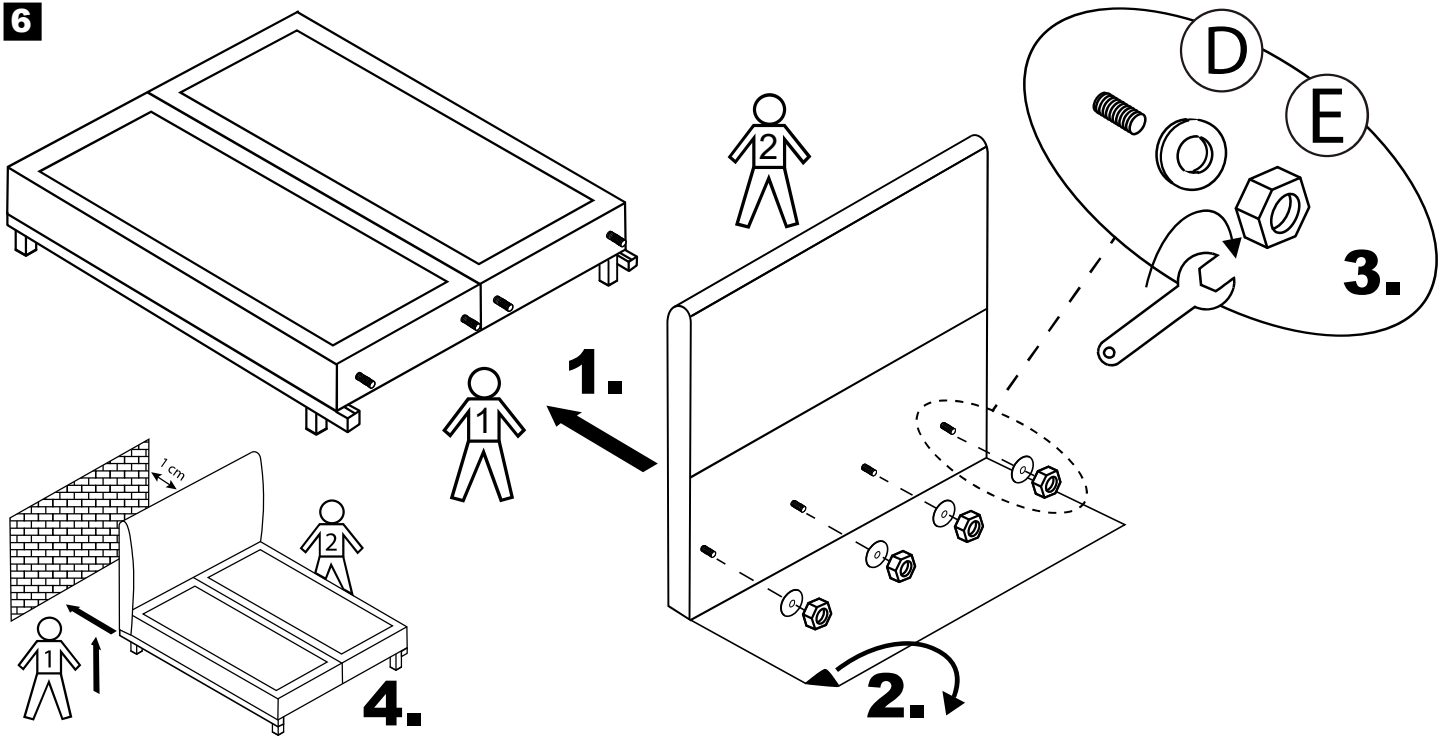

**8**

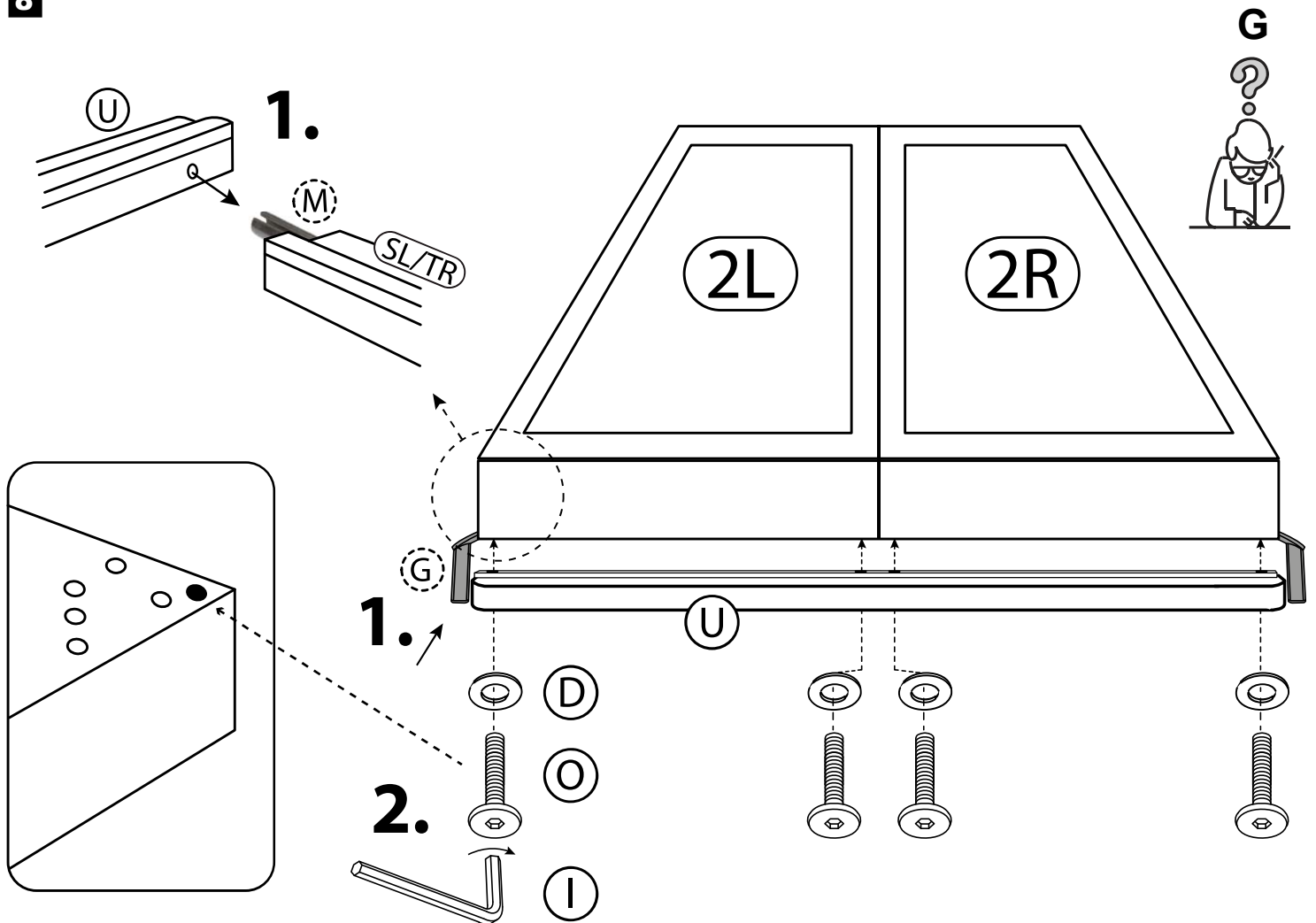

**9**

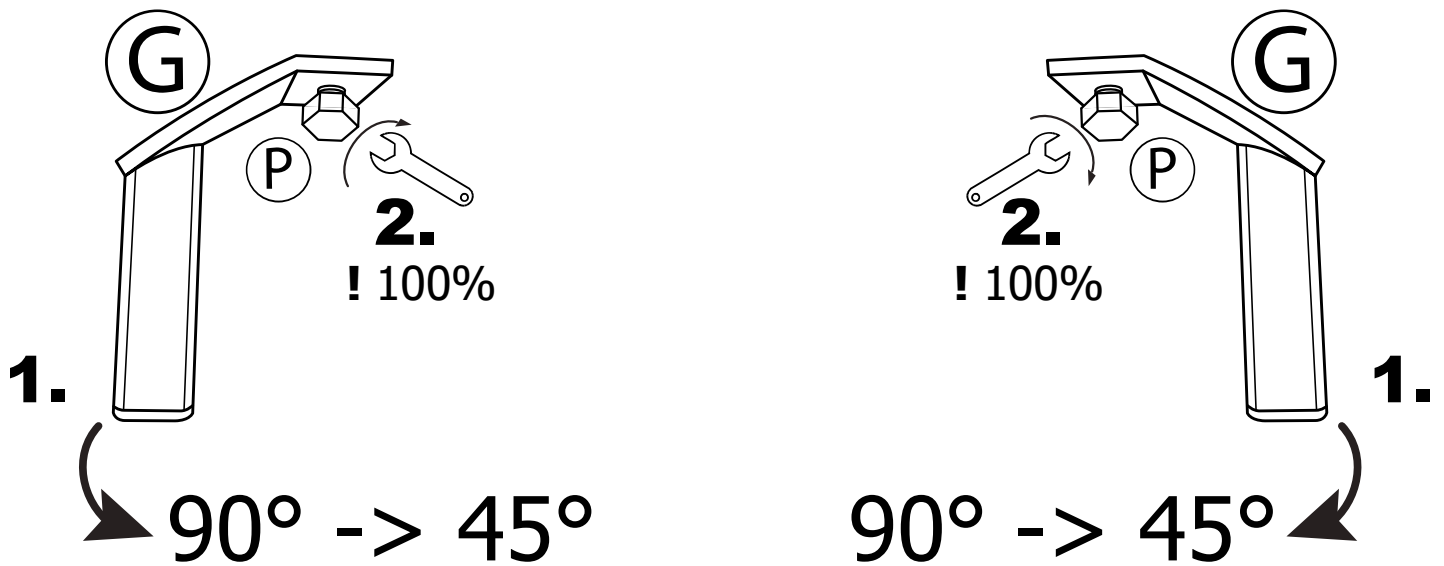

# DELPHI

Boxspring

140 x 200 cm  
160 x 200 cm / 180 x 200 cm

10

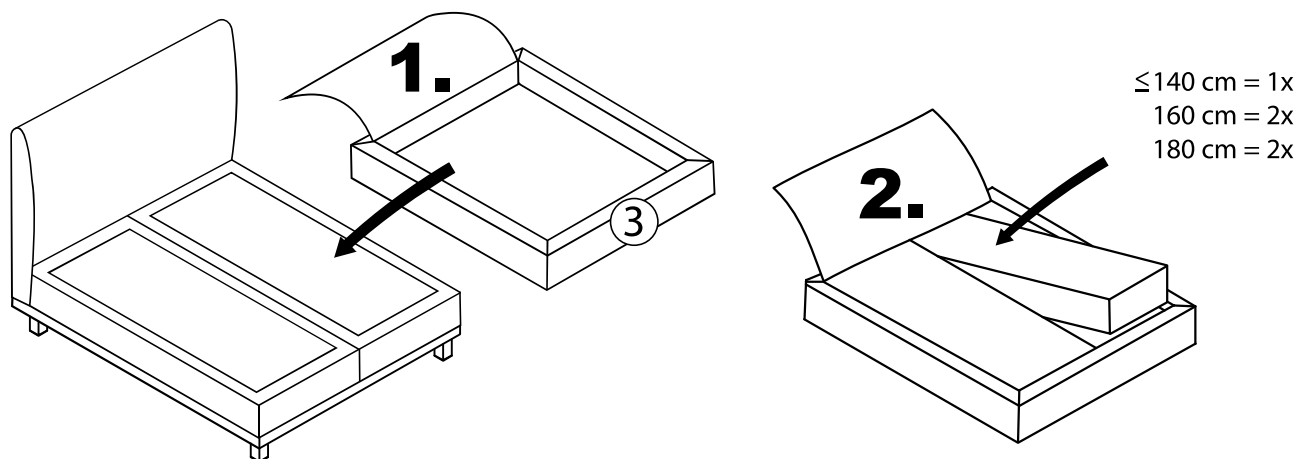

11

